

treehouse



bejot:

treehouse 2-person closed acoustic booths



upholstery capabilities



first color of the fabric

ScW - internal walls

second color of the fabric

ScZ - external walls

third color of the fabric

Si - seat

Op - backrest

frame, door handle and barstool leg from metal powder coated (structure)

- RAL9010s
- RAL7047s
- RAL7045s
- RAL7024s
- RAL9005s

multimedia panel

frame enabling on assembly of a holder for 32-inch TV set

- laminated board

- W1000 ST9
- U708 ST9
- U961 ST2
- U999 ST2
- H1180 ST37
- HPL

- white
- black
- fabric upholstered inner or outer panels

floor

- dark gray felt floor covering (V50)

- wood (oak)
- O1
- O2
- O3
- O4

optional swivel stool (2S) or sofa (2SF)

acoustic glass
safety according to ČSN EN 12600 standard

frame connection plugs

- white for frame in RAL 9010s
- black for frames in RAL 7047s, 7045s, 7024s, 9005s

tabletop

- laminated board

- W1000 ST9
- U708 ST9
- U961 ST2
- U999 ST2
- H1180 ST37

- HPL

- white
- black

- wood

- finger joint solid oak wood

wooden external panels or sound absorbing upholstered panels

- wood (oak)

- O1
- O2
- O3
- O4

- over a dozen types of fabrics in a wide range of colors

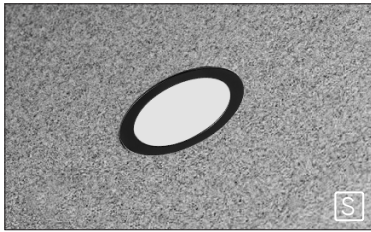

LED lighting 



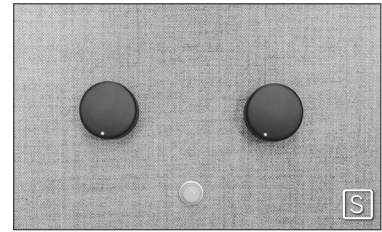

ventilation duct in the underside of the seat 



smooth light intensity and ventilation regulation 



mediaport and power supply 230 V   

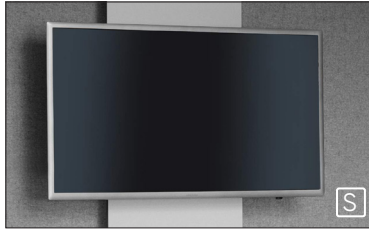

option to install a 32" TV on a panel 
(TV is not included in the offer)



transport wheels 



foot adjustment plugs 



Bluetooth®-controlled invisible audio system 



air purifier 

 standard

 option

Detailed information on standard/optional equipment can be found in the price list.

lighting

Efficient, energy-saving LED lighting adapted for reading, activated automatically due to a motion sensor. Option of adjusting light intensity with a potentiometer. Color temperature 4300 K, brightness 390 Lm, powered by 12 V.

ventilation

Efficient ventilation system, used quiet fans with an air flow of approx. 160 m³/h. The quantity of air has been adjusted so to ensure optimal user comfort. The ventilation is activated automatically thanks to the motion sensor. It has the ability to adjust the airflow rate. Ventilation function – after leaving the booth, the ventilation will work for another 3 minutes to ensure comfort for the subsequent users.

electrical installation

Safe electrical installation, components made in 12 V standard. The set includes 2.5 m power cord (plug: type E – Poland, France; type F – Germany, type G – United Kingdom).

mediaport

The set includes a standard mediaport ([type]3VHCC) with 1 voltage socket 230V (type E – Poland, France; type F – Germany, type G – United Kingdom), 1x HDMI, 2x USB charger and TV cable grommet.

transport wheels

Optional equipment - built-in transport wheels for easy movement of the booth. To stabilize and level the booth, the transport wheels must be replaced by feet. To adjust the feet, remove the black plugs in the floor and use a socket wrench (7 mm) or flat head screwdriver to raise or lower the feet to the desired height.

system audio

Optional audio system with mono amplifier and Bluetooth® control invisibly mounted in the multimedia panel. The system works with the use of a converter that vibrates the entire multimedia panel which acts as membrane that emits acoustic waves inside and outside the booth. Perfect for listening to music or playing presentations. Power consumption in operating mode: 7 W, in standby mode: <0,3 W. Acoustic power: 5 W (RMS). Rated voltage: 12 V.

air purifier

The purifier is an optional booth accessory which draws air and passes it through a titanium dioxide plate. The air combines with UVA light to produce a photonic-catalytic reaction which eliminates up to 99% harmful bacteria and viruses from the air. The purification process can also eliminate odors, leaving the air in the booth clean and fresh. The titanium dioxide plate can be removed and washed and then put back in place making maintenance less time-consuming and eliminating the need to constantly buy and replace filters.

Air flow 6,5 m³, noise level < 25 dB, dimensions 80x80x50 mm. Mounted under the tabletop.

acoustic information

acoustic, toughened, laminated glass

according to standards: EN ISO 10140, ISO 717-1

Special acoustic, toughened, laminated glass with the increased sound insulation properties: $R_w = 38$ dB

acoustic insulating power of the booth

Optimal acoustic insulation improves comfort and productivity, facilitates conversation and videoconferencing, reduces fatigue and limits excess stimuli.

reduction in speech loudness

The loudness of a conversation conducted by a person inside the Treehouse booth is reduced by half (dB), whereas the perceived difference in loudness reduction is as many as 6 times! Due to the aforementioned a confidentiality of the conversation inside the booth is maintained.

short reverberation time inside the booth

The Treehouse booth is characterized by a short reverberation time. Thanks to this, our interlocutor will understand us well during the phone call or a teleconference. Also, the unpleasant flutter echo, the so-called "chatter effect", will not be heard inside it.

sound absorption coefficient

The Treehouse acoustic booth, in an upholstered version on the outside, improves the acoustic conditions in the room in which it stands. One booth can replace several Selva wall or ceiling panels.

noise level of the fans outside and inside the booth

The Treehouse booths are equipped with an efficient ventilation system. The quiet fans with a high airflow have been used. The air volume has been adjusted to provide optimum for the user.

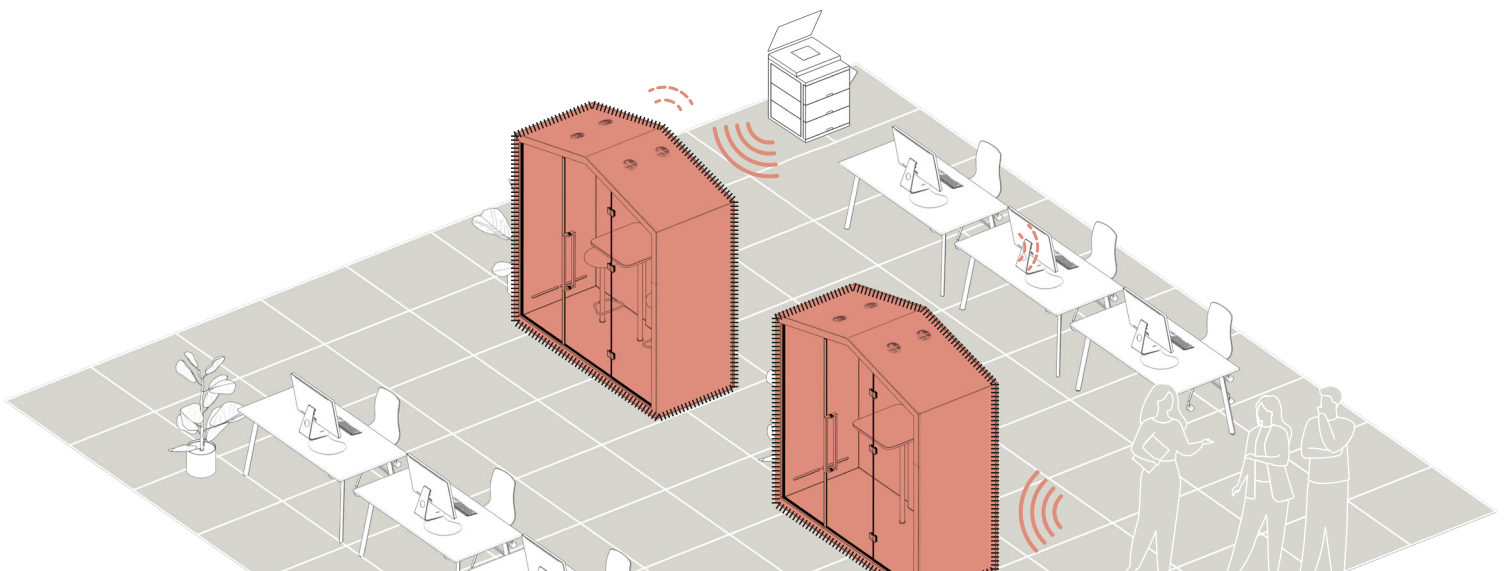

technical data

Dimensions are expressed in millimeters.

Dimensions are approximate and may vary depending on the selected product configuration. The requirements of the standard are always fulfilled.

The product sheet contains a description of the color options, variants of the wall, floor and panel finishes, as well as the furnishing components possible to be installed.

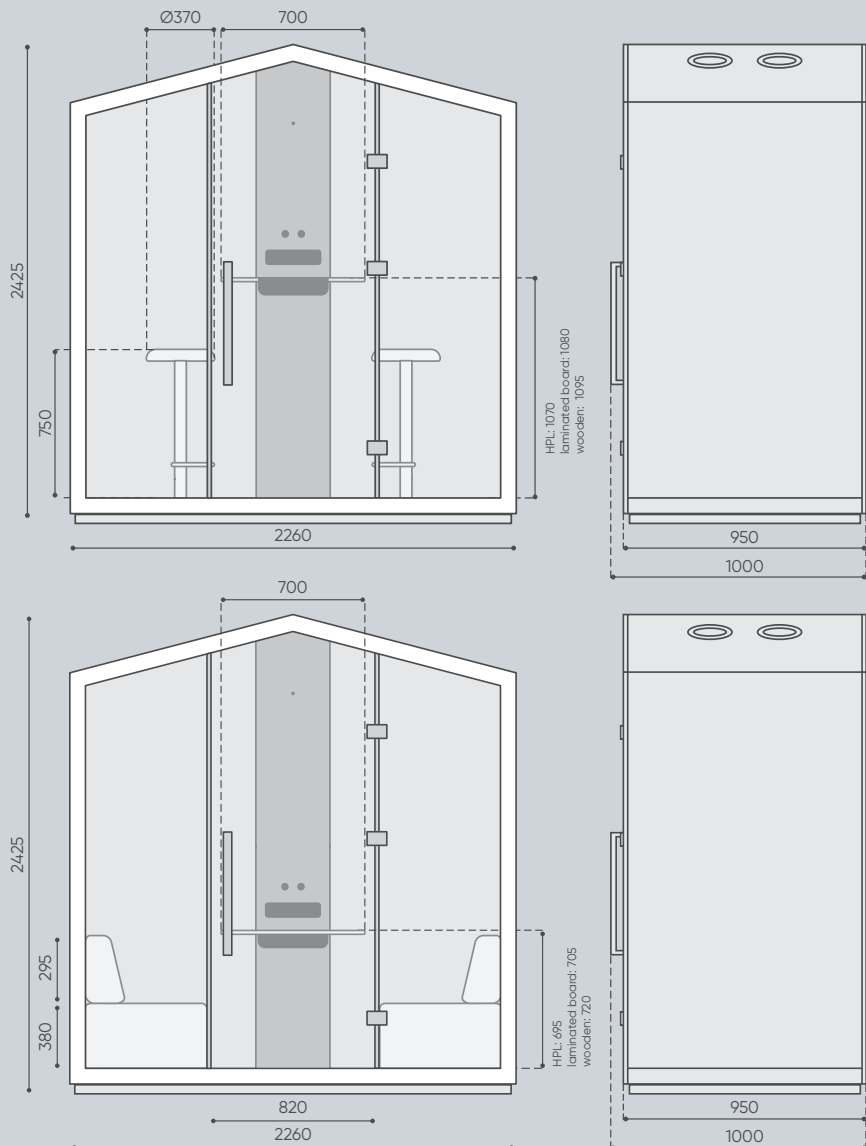

package

	THS 2SF G1	THSW 2SF G1	THS 2SF G2	THSW 2SF G2
net product weight	525	565	590	650
gross cardboard weight no. 1	445	475	500	545
gross cardboard weight no. 2	190	200	200	215

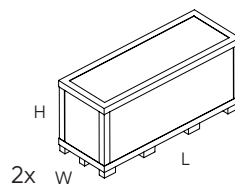

cardboard box
with a dedicated
cardboard pallet

H: 1128
L: 2434
W: 892

Being environmentally friendly is important to us, that's why we have reduced the amount of packaging which makes it easier to stack, pack and dispose of while keeping the product safe during transportation.

	THS 2S G1	THS 2T G1	THSW 2S G1	THSW 2T G1	THS 2S G2	THS 2T G2	THSW 2S G2	THSW 2T G2
net product weight	495	485	545	535	555	545	605	595
gross cardboard weight no. 1	425	415	465	455	470	460	505	495
gross cardboard weight no. 2	180	180	190	190	195	210	210	190

product ecology parameters



social responsibility

Quality, design and ergonomics have always been synonymous with Bejot – but our furniture is not the only aspect that needs daily development. A sustainable development strategy is equally important in our business. For us, this means that we operate with integrity, in an environmentally friendly manner, in compliance with applicable laws and in respect for human rights.

certified products

We have been operating to ISO standards for many years, both in terms of quality management (**ISO 9001:2015**), environmental management (**ISO 14001:2015**) and occupational health and safety. We examine and test all our products according to the latest standards. Treehouse THS1 acoustic booths were certified according to **international standards (ISO 354, ISO 11957)**, so we can be sure to deliver a top-quality product that guarantees a high level of comfort at work. The certifications confirm our commitment to environmental protection, excellent quality management, operational flow, as well as continuous improvement and development.

conscious choices

We take a responsible approach to the design process, introducing the principle of minimising end-of-life waste by identifying the possibility of disassembling the product according to the type of raw material already at the outset. When selecting components, we only use suppliers that meet our requirements. We help our Customers extend the service life of our products by providing a **5-year warranty and post-warranty service**.

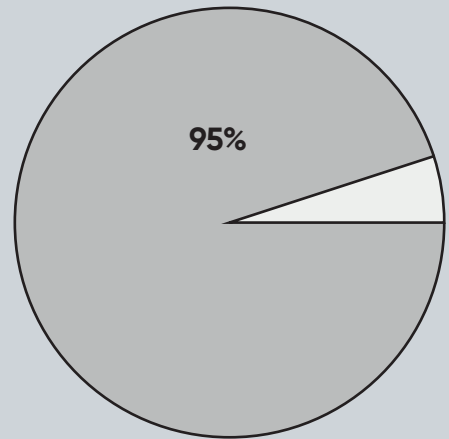
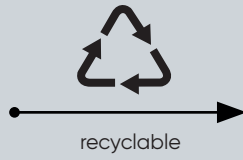
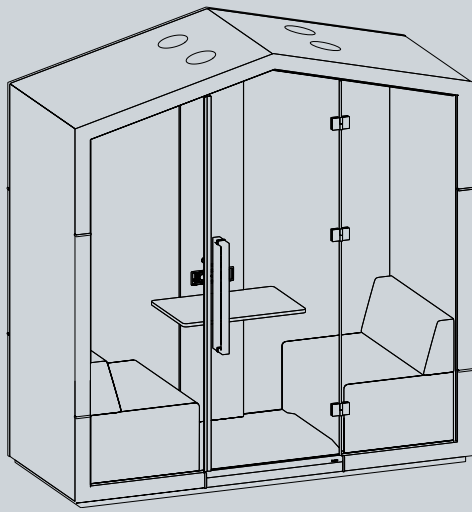

recycling

95% of the materials used in the THS 2SF G2 booth (in the Blazer fabric) can be recycled.

material composition

Percentage share, by weight, of a given raw material in the Treehouse THS 2 SF G2 booth.

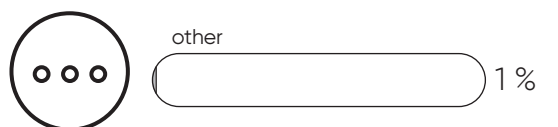
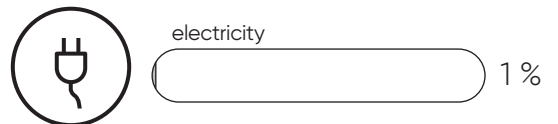
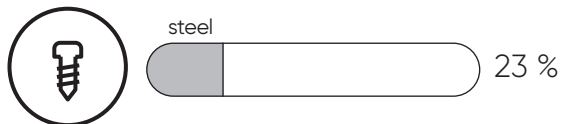
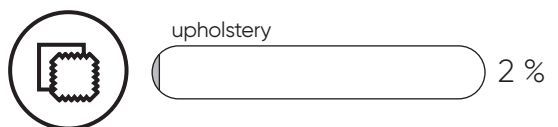
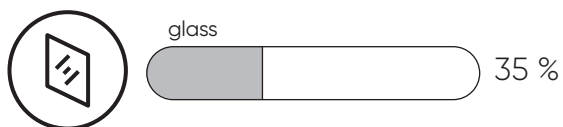
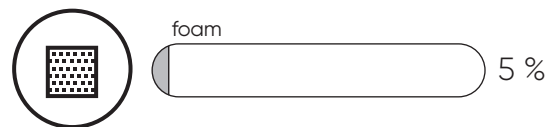
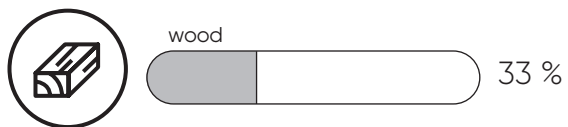

Bejot sp. z o.o.

ul. Wybickiego 2A, Manieczki, 63-112 Brodnica n. Poznań, POLAND

tel.: +48 (61) 281 22 25, e-mail: biuro@bejot.eu

www.bejot.eu

edition 08/2021